

Model 871 Four Wheel Hose Cart Owner's Manual

IMPORTANT: READ THE OWNER'S MANUAL BEFORE ASSEMBLING

TOOLS REQUIRED: TWO ADJUSTABLE WRENCHES; HAND PUMP

Estimated assembly time: 30 minutes

PARTS LIST

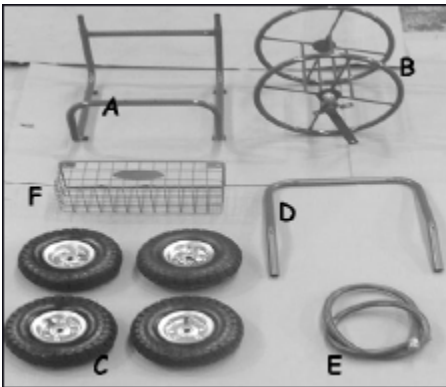

- A. Frame (1 unit)
- B. Spool w/ Crank Handle (1)
- C. Tires (4)
- D. U-Handle (1)
- E. Leader Hose (1)
- F. Basket (1)

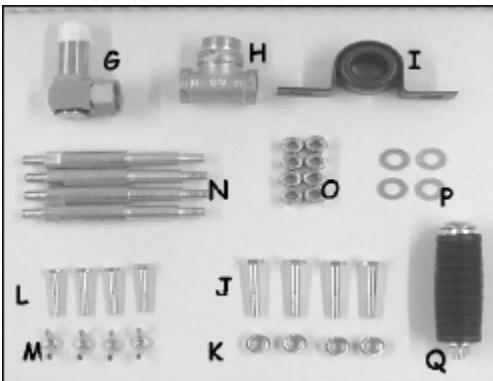

- G. Brass Swivel (1)
- H. Galvanized Tee (1)
- I. U-Bushing (1)
- J. 1.75" Bolts (4)
- K. Lock Nuts (4)
- L. 1.44" Bolts (4)
- M. Wing Nuts (4)
- N. Axle Bolts (4)
- O. Axle Nuts (8)
- P. Axle Washers (4)
- Q. Rubber Handle w/ Bolt (1)

IMPORTANT:

LAYOUT ALL PARTS AND FASTENERS. MAKE SURE ALL PARTS ARE ACCOUNTED FOR. IF ANY PART IS MISSING PLEASE CONTACT THE MANUFACTURER. **DO NOT CONTACT THE RETAILER.**

1. Turn Frame (A) on its back. Insert Axle Bolt (N) thru the axle bushing on the. Put axle nut (O) on the axle.
Hold the axle bolt with one wrench and tighten the nut on the inside of the frame with another wrench. Tighten securely. Repeat for the remaining axles.

See Figure 1.

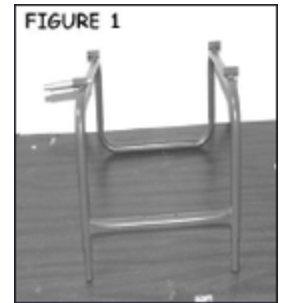

2. Place the wheel over the axle with the air valve facing out. Place the axle washer (P) over the thread and screw on axle nut (O) and tighten securely. Repeat for each remaining wheels.

See Figures 2 & 3.

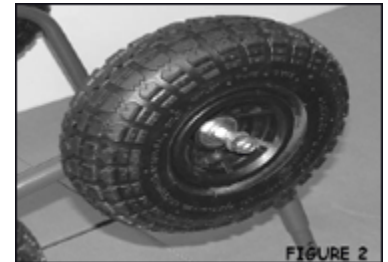

3. Set cart upright on the wheels.

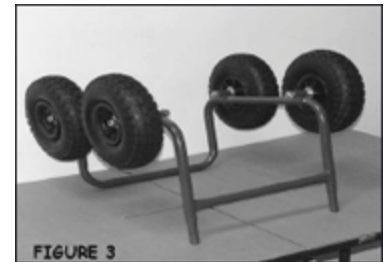

4. Insert the Brass Swivel (G) through the U-bushing (I) and screw the end of the swivel into the galvanized tee (H). **See Figure 4.** Using a wrench, tighten the swivel into the galvanized tee. Tighten securely but do not over tighten. Over tightening the swivel could cause leakage.

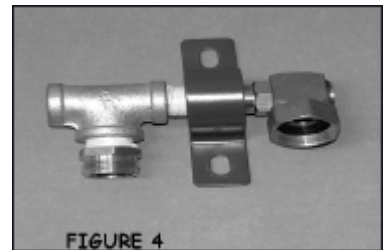

5. Screw the galvanized tee (H) onto the spool (B) end. Tighten with wrench.

See Figure 5.

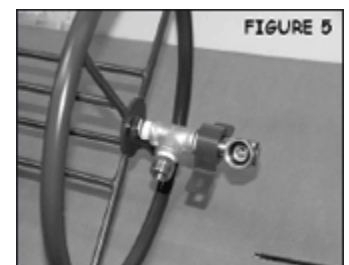

6. Place the spool (B) on the frame so the bushings are oriented over the holes on the frame. You may have to compress the spring to get the spool oriented properly.

See Figure 6.

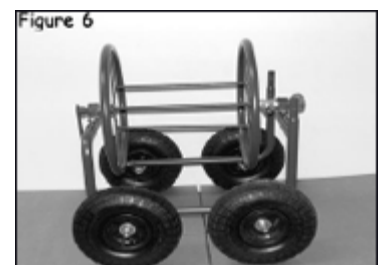

7. Using the 1.75" bolts (J), insert them thru the bushing and thru the holes on the frame. Attach lock nuts (K). Repeat for other side of the spool. After the 4 bolts and nuts are attached you may tighten the nuts.
See Figure 7.

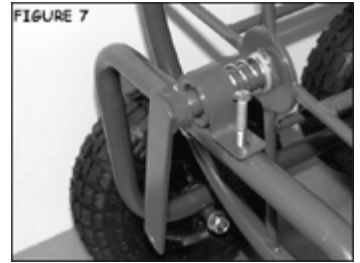

8. Attach basket (F) using 1.44" bolts, part (L) and fasten with wing nuts, part (M) to the U-handle extensions and align the holes. Insert 1.44" Bolts (L) thru handle holes and attach wing nuts (M). Hand tighten.
See Figure 8.

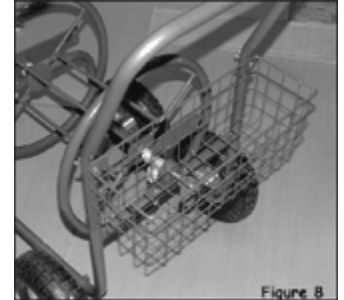

9. Attach rubber handle (Q) to crank handle using handle bolt and nut. Tighten securely.
See Figure 9.

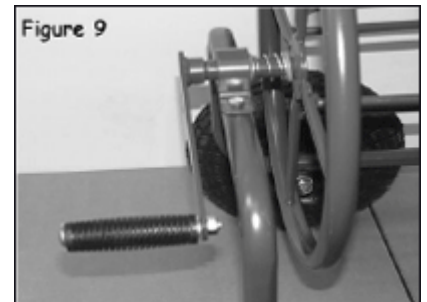

10. Attach the Leader Hose (E) to the end of swivel. **DO NOT OVERTIGHTEN.**
See Figure 10.

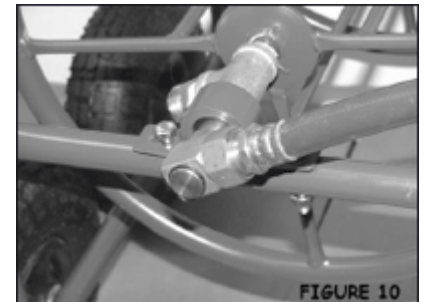

11. FILLING THE TIRES WITH AIR:

The recommended pressure for the tires is 15 PSI.

WARNING! DO NOT OVERINFLATE!

Over inflation could cause the tires to explode. A hand pump (bicycle pump) is highly recommended when inflating the tires. If a compressor is used, use with **extreme** caution! These tires are small and pressure can build quickly.

12. Attaching Your Garden Hose:

The 871 is designed to hold up to 250' of 5/8" garden hose. Attach your hose to the brass adapter (on the galvanized tee).

Loop the hose over the spool end (as shown) to avoid kinking.

See Figure 11.

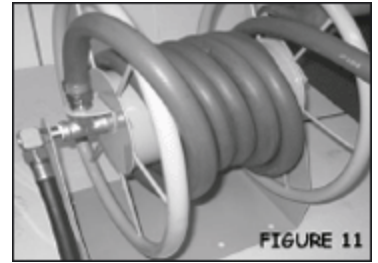

13. Your Model 871 hose cart is now ready to use.

Attach the end of the leader hose to your water supply.

Curing a Leaking Swivel

Problem:

Your new hose reel or hose reel cart is leaking at the swivel.

Solution:

It is normal for the swivel to leak slightly until the O-rings are wet and have seated. If the leaking continues, you don't need to take the cart back to the store. This is a simple problem and is easily fixed by a simple procedure.

1. If the leader hose is attached to the swivel, unscrew the hose and look inside the swivel.
2. Using either a hex key or a large screw driver, insert the tool into the hex opening and gently tighten the threaded insert. **DO NOT OVER TIGHTEN!**
3. This should stop the leaking.
4. If the unit is still leaks, please check that the hose washer is inside the nut. You may contact the manufacturer for a new hose washer or obtain one at any hardware store.
5. If your swivel is old, the O-rings may be worn. Please contact the manufacturer for a new set of O-rings.
6. If these steps do not solve your leaking problem, and then contact the manufacturer.

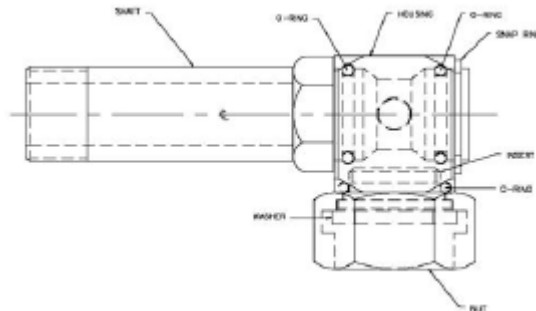
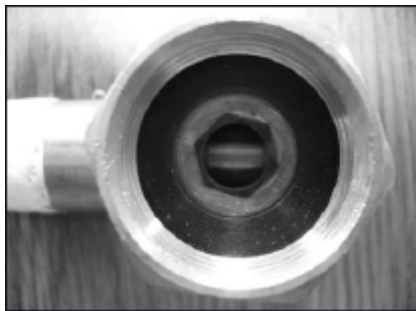

Care Instructions

Rust

Your hose reel will give you many seasons of reliable and functional hose storage. As with any steel product, there is always the chance for rust developing over time. Your hose reel finish is designed for industrial applications, but even the toughest of coatings can be compromised by scratches. Such minor surface damage can occur in shipping despite our best efforts. We have found that most scratches occur during assembly and/or installation (in the case of wall mounted hose reels). If the base metal is exposed to the elements long enough, rust will develop.

In the case of wall-mounted reels, be sure to use stainless steel mounting hardware. Also, remember to use the correct size and quantity of hardware to properly support the total weight of the unit. A standard 100' length of garden hose weighs approximately 15 pounds. Filled with water, the additional weight can exceed 20 pounds. The mounting hardware must be able to support the combined weight of the unit itself, hose, plus water.

We recommend that you periodically inspect your reel for any surface damage. Scratched can easily be repaired by using standard automotive touch-up body paint. Some of our most loyal customers recommend that at the end of each season, the unit be cleaned and painted with a clear acrylic paint.

Two other sources of rust acceleration is exposing the reel to yard fertilizers or leaving your hose reel standing in grass. Be sure to rinse off your hose reel after it comes in contact with freshly fertilized grass. Also, try to park your hose reel on solid ground. Leaving it standing on top of vegetation promotes condensation on the undercarriage of the unit.

Leaks

Your hose reel is manufactured with the finest quality components available. All components are manufactured to rigorous quality standards not common in other consumer grade hose reels available today. When you install your hose reel, be sure the hose washers are in place and all fittings are secure. **DO NOT OVERTIGHTEN** as you might damage the components. If you live in more temperate climates, be sure to drain the unit of any residual water before storing. **DO NOT EXPOSE THE UNIT TO FREEZING TEMPERATURES** while water remains in the plumbing system.

Troubleshooting Guide

Problem: Swivel head is not rotating, causing the leader hose to kink up.

Solution: Remove leader hose and turn the square head of the swivel several times; apply lubricant.

Problem: Leaking Fixtures (galvanized tee; brass coupling; swivel)

Solution: Apply Teflon/Plumber's Tape or/and make sure fixtures are tightened.

TIPS

- **DO NOT** use a compressor while inflating the tires; hand pump only. 15 PSI maximum
- To help delay rust, check for any scratches on your hose cart. Apply clear acrylic/weatherproof paint to avoid rusting.
- Drain water before storing.
- **DO NOT** drink water from hose.